

MULTISTRADA V4





Index

Multistrada V4

- 4 Rule all roads
- 7 The new Multistrada V4
- 10 The Multistrada World

More Multistrada than ever

- 15 The heart is the strongest muscle
- 22 Conquering stare
- 24 Engineered for comfort
- 27 All the comfort of aerodynamics
- 28 Owning any road has never been so easy
- 32 Only the pleasure of the ride
- 34 Connected intelligence

- 38 Dynamic intelligence
- 40 Servicing and maintenance
- 42 Technical sheet

Increasingly customised

- 44 Versions
- 50 Trim packs
- 53 Accessory Packs
- 64 Flaunt your freedom

The greatest journey

- 70 The genesis of the Multistrada V4
- 74 A world of emotions
- 78 Ducati Experience
- 80 @ducatimultistradav4 on Instagram

Rule all roads

Now more than ever, the new Multistrada V4 is ready to let you rule any road you choose to explore.

Its new 1,158 cc and 170 hp V4 heart, smooth and regular, robust, lightweight and compact, is ready to push you over the boundaries. Its chassis is designed to ensure full control and maximum precision on the road. Its advanced systems will allow you to travel with the sole objective of enjoying the ride. And with its state-of-the-art electronic equipment it will give you the certainty of reaching any destination, in complete safety and comfort.

For a riding experience that goes far beyond anything you've ever experienced on a motorcycle.





The new Multistrada V4

Feel at ease on any path you choose to travel with your new Multistrada V4, whether asphalt or dirt, fast turns, or slow, coastal roads. Experience the pleasure of total control, at all times and on any terrain.

Rest assured that you can push yourself further than ever before. Everything on this bike is created to offer maximum stability and durability. This means you can experience the greatest emotions and the ultimate riding experience, every time you decide to travel with your new Multistrada V4 and wherever you choose to go.

However long or arduous your journey, you are always in full control.

It is "Sport" because it is light and compact, driven by 170 hp and equipped with MotoGP electronics and a chassis that guarantees agility, for exciting and efficient mixed riding.

It is "Touring" thanks to the main maintenance interval at 36,000 miles, the obsessive attention paid in the development phase to the riding comfort, the Radar systems, the map navigator displayed on the dashboard and the full-LED lighting system with cornering light.

It is "Enduro" thanks to the wide ground clearance, the electronic suspensions, the surprising fluidity of delivery and its shapes also designed for standing riding.

It is "Urban" because it guarantees easy maneuvering at low speeds, but also maximum riding pleasure thanks to the connectivity of the smartphone and the accurate study aimed at thermal comfort.

It is the new Multistrada V4, and it is the greatest Multistrada ever.





Design

Designed to conquer all roads, following an approach that combines aesthetics, ergonomics and aerodynamics, the Multistrada V4 strikes at first sight for the fluidity of its lines, the lightness and the compactness. And for the unmistakable Ducati personality.

The compact and sophisticated front, with its characteristic DRL, shows the resolute look of someone who is ready to take on any terrain. Its surfaces convey a feeling of solidity without heaviness. The arrows integrated in the side panels, the double-sided swingarm and the rear trellis frame are cycling solutions leading to an extremely robust result, from both an aesthetic and a functional point of view.

Pag. 22



Electronics

A bike never this yours, customizable in every aspect, from dynamic behavior to connectivity solutions. A bike never this safe, thanks to an electronic equipment that marks the state of the art for Ducati and for the entire motorcycle industry.

No matter what road you want to take. With the Multistrada V4 you will always arrive at your destination, regardless of how long or difficult the journey is. The connectivity technologies, which can be controlled via the new HMI interface, enhance the pleasure of riding even on long distances, while the rider assistance systems raise safety to unprecedented levels. Like the front and rear radar technology, which reconstructs the reality around the bike to support and make your ride more comfortable.

Pag. 34

Engine

The heart of the Multistrada V4 is the V4 Granturismo, the latest creation in Ducati's long motoring history, a new technological pillar that elevates the sportiness imprinted in the Ducati DNA towards new horizons of usability and solidity.

Derived from the experience of the Desmosedici Stradale, made lighter and more compact than the Testastretta DVT by a meticulous work in the design and development phase, the new V4 Granturismo is an engine with 1,158 cc and 170 hp of power, smooth and regular at low revs, exciting and performing when you want to open the throttle. Designed for long mileage, its spring-loaded timing system extends the main maintenance interval to 36,000 miles, a value that has no equal in today's motorcycling world.

Pag. 15



Dynamics

Designed to offer you maximum stability and comfort in every situation, the Multistrada V4's advanced chassis will allow you to get the most out of any condition of use, whatever your riding level.

Intuitive and easy to ride, the bike is always ready to elevate your performance to a higher level, both on and off-road. The 19" front wheel ensures a smooth, round, yet dynamic ride. The new generation double-sided swingarm, inspired by additive technology, is the perfect balance of compactness, stiffness and lightness that will give you unlimited freedom. And thanks to the long and meticulous NVH development work that minimized annoyances due to noise, wind and vibration, you will feel nothing but the pure pleasure of riding.

Pag. 28



Versions, trim and accessory packs

Create your tailor-made Multistrada V4: discover all the accessories and the all-new trim packs, the new configurations with accessories coming straight from the Ducati factory.

Pag. 44



Making of

Discover the ideas, visions and people who have contributed to the realization of the Multistrada V4, from the first sketches of the V4 Granturismo to the final tests on the roads across all Italy.

Pag. 60



Apparel

Choose comfort, but don't give up the style: with the new Ducati apparel collection you can enjoy every moment of your journey to the best, even when you're not on the saddle.

Pag. 54



Ducati Experience

Experience the world of the Multistrada. The Ducati Experience offers exclusive chances to improve your riding skills and spend unforgettable moments riding the Multistrada V4.

Pag. 68

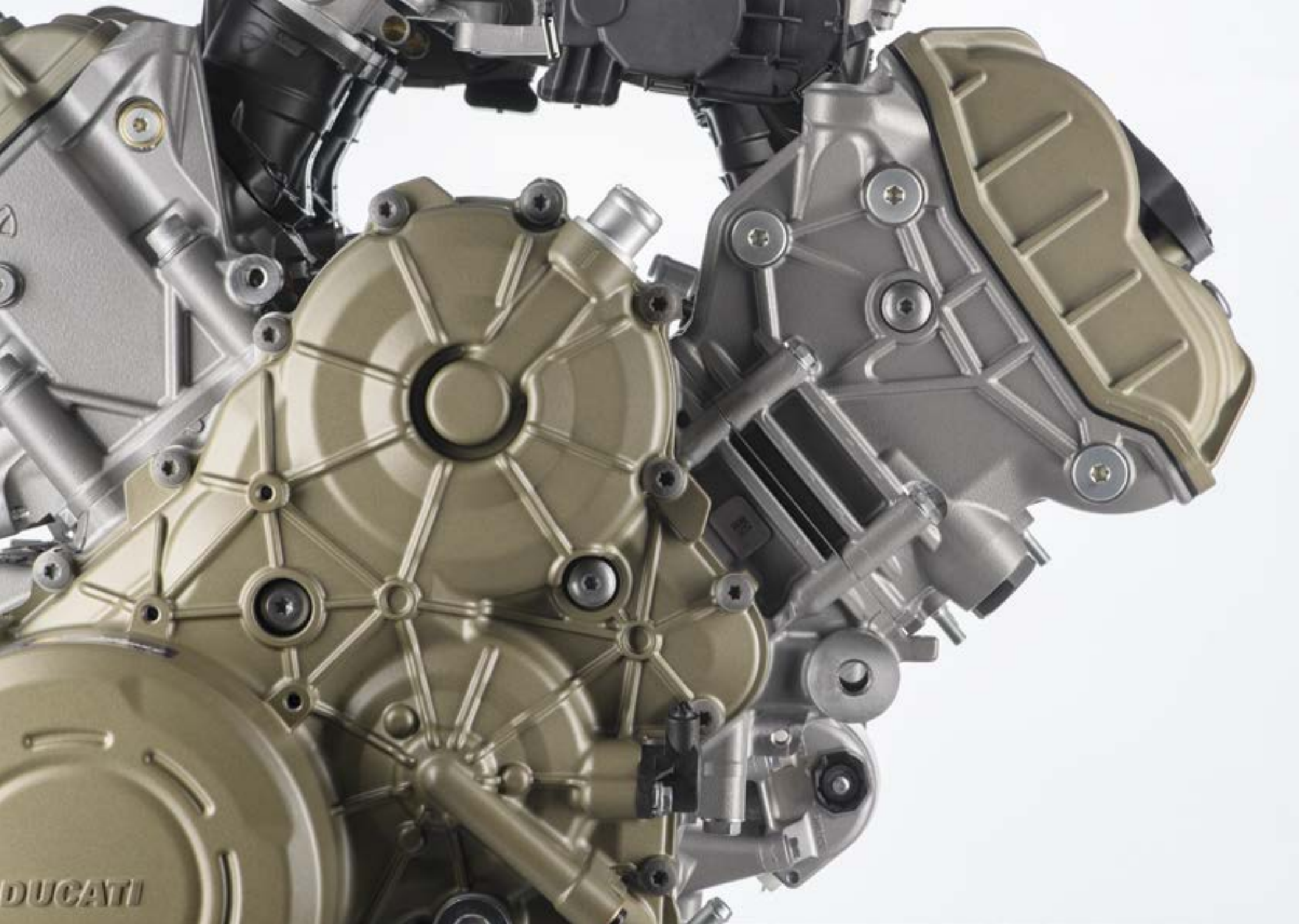

ENGINE

The heart is the strongest muscle

Progressive and regular when it pulses at low revs, electrifying and high-performance when it beats at high speed, the new Multistrada V4 is powered by an engine as robust as it is thrilling, based on a new technological paradigm that marries Ducati sports attitude with the pure pleasure of travel. Just as its name suggests, an unmistakable expression of Italian motoring history: V4 Granturismo.

A new V4, deriving from the Desmosedici Stradale, is designed to give life to the smoothest, most versatile, and robust Ducati engine of all time. An engine that is lightweight and compact, thanks to meticulous design work that extends from the general layout to the conception of every single component.

An increase in bore means less bulk, which results in the ideal seat height and a perfectly positioned centre of gravity. With 1158 cc and its four cylinders arranged as a 90° V, the V4 Granturismo is not just the product of advanced engineering, but also the launch pad for an efficient chassis, designed to ensure total usability and rideability in all conditions.



Ducati has always paid great attention to the reliability, robustness, and durability of its engines. The new V4 Granturismo marks a turning point not just in the history of the Borgo Panigale firm, but the entire motorcycling industry. Developed over many years of desmodromic system evolution, Ducati solutions in terms of materials, heat treatments and production tolerances have been applied to the spring valve train, allowing the V4 Granturismo to set new standards.



A 60,000 km (36,000 miles) standard in fact. This is the main service interval for the new V4 Granturismo. A value that equates to 1.5 times the circumference of the earth and a record in a segment for which the average remains 25,000 km, so less than half. An engineering feat that underlines the extreme durability of the new Multistrada V4 engine. A milestone that, together with an oil change service interval of 15,000 km (9,000 miles) or two years, essentially means one thing for a rider: lower costs and less frequent maintenance operations, and so more time to enjoy the bike.

**Designed for long distances.
So long that one world is just not enough.**

Every single component of the V4 Granturismo has been designed with the intention of achieving an engine that is extremely compact, even more so than the V2. With respect to the 1260 cc Testastretta DVT, the V4 Granturismo is 1.2 kg lighter, 85 mm shorter, and 95 mm lower, despite an increase in width of just 20 mm.

And yet the V4 Granturismo is a powerful engine, with 170 hp maximum power and 12.7 kgm of torque ready to transmit all that Ducati sports DNA. But the V4 Granturismo also performs off-road, with smooth and progressive power delivery already at medium/low speeds.

**Gradual at low rpm.
Rich in torque at mid-range.
Exciting at high engine speeds.**

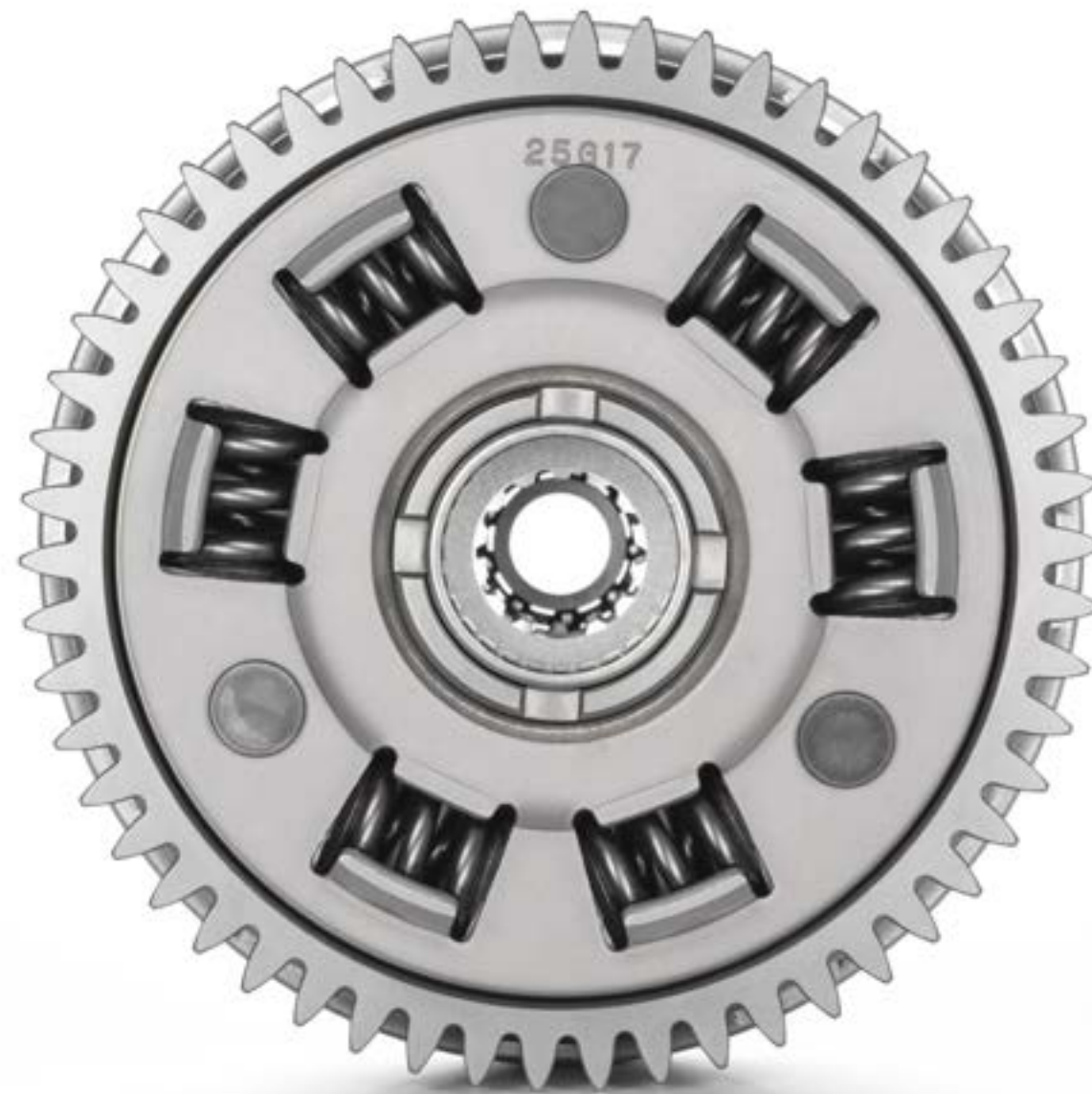

The V4 Granturismo is a versatile engine which, in order to achieve the goals of regularity and fluidity ideal for a travel-enduro, incorporates and evolves many important technical innovations developed by Ducati. The entire thermal unit has been redesigned. A new flat sump makes the engine more compact in height and allows to increase the ground clearance, for greater riding comfort.

The fluidity, robustness, and versatility of the V4 Granturismo mark the start of a new future. A future that nevertheless retains the unmistakable hallmark of Ducati sports emotion.

The V4 Granturismo is equipped with a Twin Pulse firing order. The 90° layout of the banks, combined with a 70° crank pin offset, does not just define that rapid firing so familiar to twin-cylinder enthusiasts, but also offers electrifying torque delivery out of the corners.

The use of a counter-rotating crankshaft – borrowed from MotoGP – reduces the gyroscopic effect that the wheels have on the vehicle. By improving handling and agility and reducing pitch in acceleration and braking, this technical solution increases both safety and riding comfort during road and touring use. The gearing is also totally dedicated, with ratios that make it more versatile.

A shorter first gear is optimised for low-speed or off-road riding, while a longer sixth gear ensures comfort on the motorway.

Careful sound quality work on the engine components guarantees that distinctive Ducati tone while ensuring the noise level is not excessive, for greater rider and passenger comfort over long distances.

To improve thermal comfort when the vehicle is stationary, the rear cylinders are deactivated, or rather switched off to lower both temperature and consumption.

The future has a familiar sound.



DESIGN

Conquering stare

An evolved, modern design created by combining style and functionality. An energetic and linear profile, which with light shapes and compact volumes conveys concreteness and solidity. Modelled to measure the aerodynamics and ergonomics of the rider, the design of the Multistrada V4 sculpts its technical soul into a harmonious whole, made up of wide and smooth surfaces just like the feeling of maximum control that the bike gives back in every riding condition.

Designed to cut through the dust, created to amplify pleasure.



The family feeling, returned by the mass loaded on the front, the extremely slim tail and the compact front, is made more modern and sportier by the DRL in Panigale style with full-LED projector. Its aggressive look, which leaves room for electronic evolution in the shape of the innovative radar, reflects the design approach of one of the most technologically advanced motorcycles ever.

From the radars to the aerodynamic appendages; from the plexiglass to the dashboard; from the blocks to the handlebars. Everything is perfectly integrated thanks to a design that combines performance and function, in which man, machine and technology come together to become one.

Engineered for comfort

Every detail is designed to combine style with functionality. The front profile of the tank and the sides are the result of extensive ergonomics research and the sophisticated coupling of complex surfaces. Greater ground clearance, designed for off-road riding, improves rider comfort, while sturdy side panels lend themselves perfectly to Enduro riding. The Multistrada V4 is designed so that any rider can easily touch the ground, thanks to a seat that is narrow in the leg area, and also move freely, even when standing on the pegs.

Elegant, but always ready for adventure.



The decision to integrate the turn signals into the side panels ensures protection against any minor side blows and increases the volume of the bike while retaining its compactness. The rear swingarm is a masterpiece of design, its slotted structure inspired by the

principles of additive technology. The rear sub-frame, with a trellis structure to better support stress and load, results in a space saving beneath the seat, which allows for the insertion of both electronic elements and seat height adjustment.

All the comfort of aerodynamics

Innovative Ducati Corse aerodynamics research is exploited to offer the most comfortable on-board experience. Aerodynamic control means that head-on air exposure is reduced to a minimum while hot air is deviated away from the rider, ensuring optimum protection and comfort.

The windshield (01A) is equipped with lateral deflectors (01B) to protect the shoulders of the rider and passenger. This ergonomic system is height adjustable (patent pending).

The internal aerodynamic bypass (02B) helps to create a jet of fresh air that can deviate the flow of hot air exiting the radiators around the rider to improve thermal comfort. The external bypass (02A) takes air from the front of the vehicle to cool the rider seat area.

The position of the front radiators is designed to allow for optimum vehicle weight distribution, a deflector in the radiator cooling outlet (03) maximising aerodynamic efficiency.

In the same way, a pair of deflectors below the fairings (04) boost the flow of fresh air towards the rider's legs, maximising thermal comfort.

Lastly, the beak (with front wing – 05), fairings, "shoulders" of the tank and radiator bypass outlets are all designed to reduce the air pressure, and resulting vibration, on the rider.



DYNAMICS

Owning any road has never been so easy

The new Multistrada V4 reaches new heights in terms of its handling, smoothness, intuitiveness, and ease of use, thanks to a body designed to offer the best possible balance between road and off-road use.

With respect to the previous generation, the compactness of the V4 Granturismo engine and the reduced wheelbase make for a shorter, more agile bike. A perfectly positioned centre of gravity makes way for a chassis that will excite any rider while ensuring maximum safety in any situation, rider and passenger comfort on long-range trips, and the pleasure of off-road performance, without forgetting its Ducati sports DNA on the road.





The 19" front wheel ensures a round, easy and intuitive ride in all conditions, guaranteeing the precision and responsiveness required by sports riding. To ensure the possibility to fit spoked rims, the Multistrada V4 is equipped with a new generation double-sided swingarm, an object with a unique design, developed by applying additive technology, which offers the perfect balance between compactness, stiffness and lightness.

The monocoque frame, conceptually similar to that of the superbike Panigale V2 and adapted for on and off-road use, allows for a significant weight reduction. Moreover, working as an airbox in accordance with the concept of structural integration, it gives high stiffness and stability at high speeds. Finally, all the other structural elements, such as the rear trellis frame, the tail and also the rear wheel, have been dimensioned and verified to ensure a high load capacity, which with over 227 kg (500 lb) sets a record for the category.

Intuitive and effective between curves, determined both on the road and in off-road.



ERGONOMICS

Only the pleasure of the ride

Increase the comfort during long highway transfers, both for the rider and the passenger: In order to achieve this goal, Ducati engineers have paid great attention to what in the car industry is called Noise, Vibration, Harshness (NVH), an engineering effort aimed at minimizing the possible sources of annoyance or stress, such as noise and vibration.

Climbing aboard the Multistrada V4 means enveloping yourself in a bubble of silence, where you can ride with your helmet open, even at high speeds. Minimal vibration, regardless of speed and load, maximises the level of comfort, particularly over long distances, while engine noise is significantly reduced thanks to a reduction in gear play.



The exhaust has been perfected, particularly for everything related to the silencer, through an accurate work of sound quality. The result, thanks also to the Twin Pulse burst order of the V4 Granturismo, is a sound with an exciting

timbre and a 100% Ducati personality, where however the volume never reaches annoying levels and does not affect the acoustic comfort of rider and passenger, especially during long journeys or long exposures.

ELECTRONICS

Connected intelligence

Raising the technological bar with cutting-edge electronic solutions has always been in the DNA of the Multistrada family. The new Multistrada V4 is equipped with all the state-of-the-art Ducati technology. The result is a riding experience that is easy, safe, intuitive, always open to performance, always adaptable to the conditions of use and the needs of each rider.

The future of riding pleasure at your disposal. Now.

Inspired by aeronautical bridges and adjustable in angle so that it is visible to riders of any height, the large instrument panel flaunts a 6.5" TFT screen (S and S Sport). High resolution and ensuring perfect visibility in any lighting, this full colour TFT display presents a new HMI interface, completely redesigned to be more flexible, easy to use and pleasing to the eye. Available in six languages, it integrates all the information a rider might need when travelling, including a dynamic navigation map, and is the first instrument panel to be equipped with optical bonding technology, which improves interface design and visibility and allows graphic dark mode even during the day.





The connectivity is at unprecedented levels, thanks to the Ducati Connect system, compatible with iOS and Android, which through the mirroring of the smartphone allows you to do everything you may need during the trip: How to search through contacts or type a number using the keypad; play your favorite music by scrolling through folders, artists, albums and playlists; set the destination and follow the navigation on the full map view integrated in the dashboard.

The entire HMI interface, and therefore all Ducati Connect functions, are conveniently controlled by an innovative joystick, located on the control block on the left side of the handlebar and equipped with backlit buttons. Once the connection between smartphone and dashboard has been established via Bluetooth and Wifi, the rider can store the phone in his pocket.

The world at your fingertips.



Dynamic intelligence

The Multistrada V4 is the first bike in the world to come complete with front and rear radar. This experimental technology from Ducati in collaboration with the Department of Electronics, Communications and Bioengineering at the Politecnico di Milano has been developed and industrialised together with Bosch, setting a new level of excellence in terms of comfort and riding assistance.

Each radar is compact in size (70 x 60 x 28 mm, similar to a modern "action camera") and integrates perfectly with the bike, at a weight of just 190 grams.

The radar positioned on the front section of the vehicle controls the ACC, or Adaptive Cruise Control function. Activated and adjusted using the dedicated buttons on the left block, the ACC makes use of calibrated and progressive braking and acceleration to automatically regulate the bike's distance (selected according to three levels) from other vehicles when riding at speeds of between 30 and 160 km/h. This makes for a more comfortable ride, particularly when covering long distances on the motorway. This car-derived system has been developed according

to the dynamics and ergonomics of a two-wheeled vehicle, with maximum deceleration limited to -0.5 g, in order to ensure that the rider maintains full control of the bike in every situation.

The rear radar is able to identify and signal any vehicles located in, or coming rapidly towards, the so-called blind spot (blind spot detection), or rather the area not visible to the rider or rear-view mirror. The presence of any vehicles is signalled with a dedicated LED, adjustable in intensity, positioned above the mirror.

The entire Multistrada V4 family is equipped with the Ducati Safety Pack, which includes the Brembo braking system with ABS Bosch 10.3ME complete with adjustable three-level cornering function. Cornering ABS works in synergy with the Bosch IMU inertial platform, which provides vehicle lean angle data in real time. In this way, the ABS control unit can effectively modulate braking power independently at each wheel, even when the bike is tilted, preventing any fall owing to the locking of the wheel.

An integral part of the same package, Multistrada V4 DTC represents the latest step in Ducati traction control

development and includes the cornering function. Via the inertial platform, the system identifies all information regarding the position and speed of the vehicle in space, intervening on the torque and ensuring smoother, more linear delivery with a gradual action that is never invasive. In this way, the rider

can avoid any loss of control. Adjustable according to eight levels in a similar way to DTC, Ducati Wheelie Control analyses the bike setting, identifies any front wheel lift, and manages the power delivery accordingly in order to ensure maximum safety in acceleration. Skyhook suspension, complete with

dedicated calibration, ensures maximum versatility in the city or on slightly uneven ground, but also optimum comfort over long distances. The control strategy, developed by Ducati, regulates the damping of the fork and single shock to support load transfer and minimises stress from the ground, to increase riding

sensitivity and make the bike more stable and comfortable. For the first time, the system integrates the Autoleveling function, which identifies the bike's load and automatically adjusts the setting, adding to the options already available to the user: rider, rider plus bags, rider and passenger, rider and passenger plus bags.

The four Riding Modes allow the bike to be adapted to all types of usage, from the city traffic or adverse weather conditions of Urban mode, to the more high-performance road setting of Sport mode, by way of Touring mode, which prepares the bike for longer journeys, and Enduro, which configures the bike for dirt riding and helps the rider navigate obstacles when off-road.

The Quick Shift Up&Down system, which uses information from the inertial platform to facilitate shifting, is also more advanced and now integrates the cornering function.

The ideal Multistrada in all conditions and for every rider.



Servicing and maintenance

Safety as standard

The continuous work that Ducati carries out in terms of design, research and development has the specific aim of ensuring bikes are always cutting-edge and offer the ultimate level of active safety. A commitment that means defining increasingly advanced systems that heighten the level of rider control during the most delicate riding phases.

The Multistrada V4 can be fully customised in terms of its suspension, performance, comfort and safety and comes complete with the most advanced rider support systems, or rather Riding Modes, Power Mode, Cornering ABS, Ducati Traction Control, Ducati Wheelie Control, Ducati Cornering Light and Ducati Brake Light.

Choose your Multistrada and start your adventure!

Ducati offers you a four-year warranty on all models in the MY 2021 Multistrada family. Born to satisfy a thirst for travel - no borders, no compromise - the Multistrada offers the utmost in technology, performance, and design. Characteristics that are combined with rider and passenger comfort to achieve just one goal, namely to cover ever-increasing distances. A warranty made possible thanks to the experience of Ducati and its dealer network. A competent and continuously updated team treats every Ducati bike with the same care provided during its design and assembly in Borgo Panigale, so that all you need think about when riding your Multistrada is the next destination.

To find out whether 4Ever Multistrada is available in your country and to receive more information, contact your Ducati dealer or visit [ducati.com](https://www.ducati.com).

Endless excitement

In designing each bike, Ducati always sets itself the goal of ensuring maximum reliability while reducing maintenance costs. A commitment that has seen it extend the main service interval to 60,000 km (36,000 miles), during which a valve clearance check and registration is carried out as required. Even the simplest operations, like the Oil Service, are now scheduled at 15,000 km (9,000 miles) or 24 months.

An interval that is unbeatable in the two-wheeled world and that only confirms the very high quality standards Ducati applies to its material selection and R&D processes. Ducati continuously invests in the technical training of its dealers. The specific knowledge of official Ducati Service network members means that all operations needed to keep every Ducati in perfect working order are meticulously carried out. Advanced equipment such as the Ducati Diagnosis System ensures every Ducati will always have the latest software updates so that the electronic systems continue to perform at the highest level.

Always by your side

One of Ducati's main goals is to offer every Ducatista the chance to enjoy unlimited and safe travel all over the world. To achieve this aim, Ducati offers a "fast delivery" original spares service, with delivery in 24/48 hours across 85% of the areas in which it operates. With a distribution network that covers more than 91 countries, thanks to 738 official Dealers and Service Points*, choosing a Ducati means you can travel worry free and in total freedom, wherever the road may take you, and count on support from our extensive Dealer network that ensures Ducati quality and professionalism is always close at hand.

738 Authorised dealers and service points

91 World countries

*Information updated as of February 2021



4|Ever
Multistrada



*Equal to 36,000 miles.



MULTISTRADA V4

Dimensions

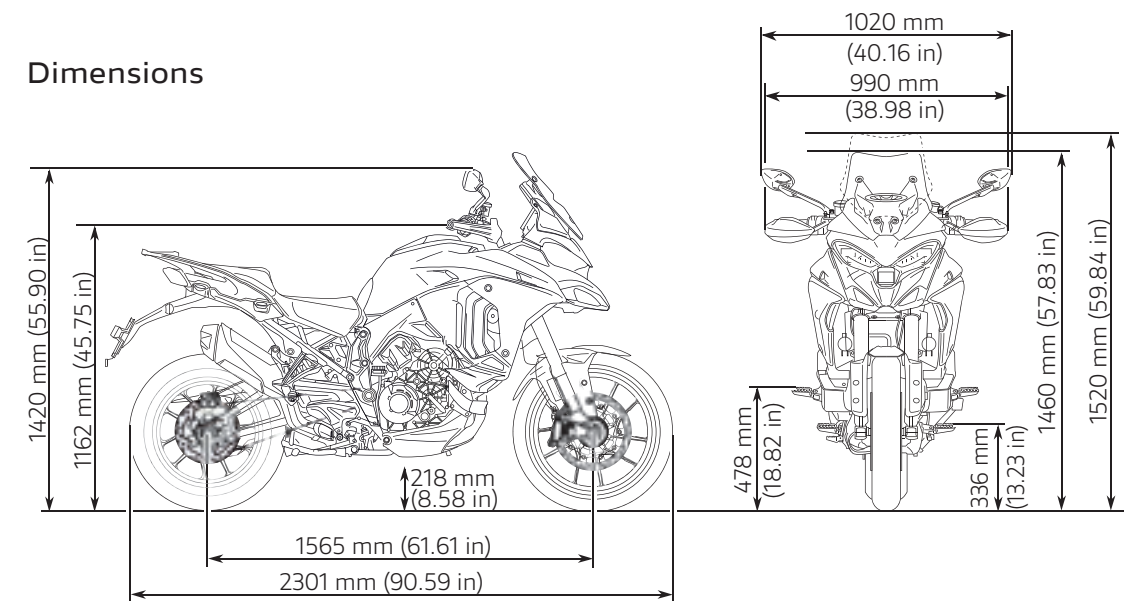

Power and torque

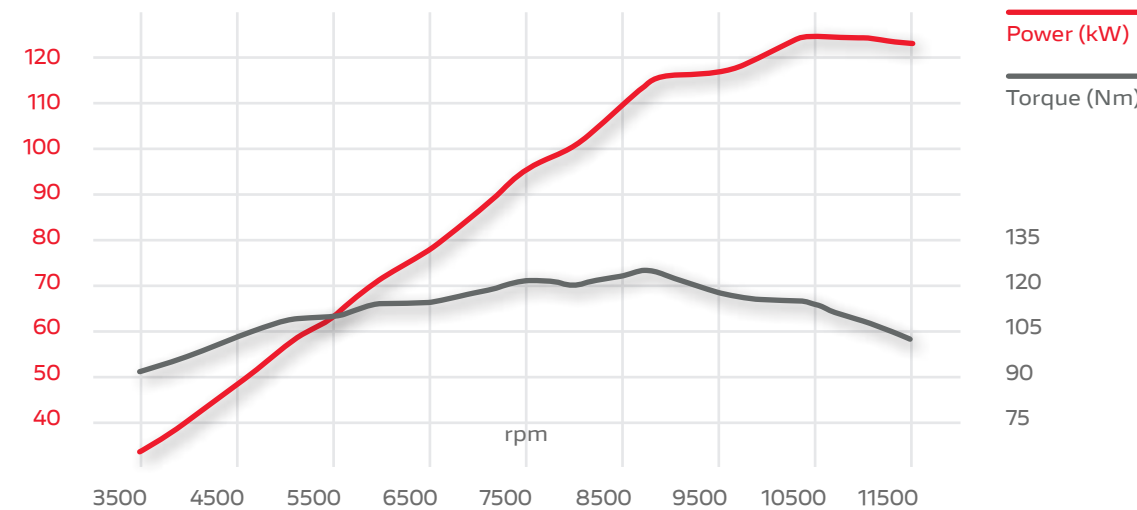

Engine

Engine V4 Granturismo, V4 - 90°, 4 valves per cylinder, counter-rotating crankshaft, Twin Pulse firing order, liquid cooled

Displacement 1,158 cc (71 cu in)

Bore X Stroke 83 mm x 53,5 mm

Compression ratio 14.0:1

Power 170 hp (125 kW) @ 10,500 rpm

Torque 12.7 kgm (125 Nm, 92 lb ft) @ 8,750 rpm

Fuel injection Electronic fuel injection system, Øeq 46 mm elliptical throttle bodies with Ride-by-Wire system

Exhaust Stainless steel muffler, double catalytic converter and 4 lambda probes

Transmission

Gearbox 6 speed

Primary drive Straight cut gears, ratio 1.8:1

Ratio 1=40/13, 2=36/16, 3=34/19, 4=31/21, 5=29/23, 6=27/25

Final drive Chain, front sprocket z16, rear sprocket z42

Clutch Multiplate wet clutch with hydraulic control, self-servo action on drive, slipper action on over-run

Chassis

Frame Aluminum monocoque frame

Front suspension Ø 50 mm fully adjustable usd fork

Front wheel Light alloy cast, 3" x 19"

Front tyre Pirelli Scorpion Trail II 120/70 ZR 19

Rear Suspension Fully adjustable monoshock, Remote spring preload adjustment, aluminium double-sided swingarm

Rear wheel Light alloy cast, 4.5" x 17"

Rear tyre Pirelli Scorpion Trail II 170/60 ZR 17

Wheel travel (front/rear) 170 mm / 180 mm (6.7 in / 7.1 in)

Front brake 2 x Ø 320 mm semi-floating discs, radially mounted Brembo monobloc 4-piston 2-pad callipers, radial master cylinder, Cornering ABS

Rear brake Ø 265 mm disc, Brembo 2-piston floating calliper, Cornering ABS

Instrumentation 5" TFT colour display

Dimensions and Weights

Dry weight 215 kg (474 lb)

Kerb weight 240 kg (529 lb)

Seat height Adjustable, 840 mm - 860 mm (33.1 in - 33.9 in)

Wheelbase 1,567 mm (61.7 in)

Rake 24,5°

Trail 102.5 mm (4.0 in)

Fuel tank capacity 22 l (5.8 US gal)

Number of seats 2

Safety equipment

Riding Modes, Power Modes, ABS Cornering, Ducati Traction Control, Ducati Wheelie Control, Daytime Running Light, Ducati Brake Light

Standard equipment

Backlit handlebar switches, 5" TFT colour display

Warranty and Maintenance

Warranty 24 months (48 months*), unlimited mileage

Maintenance 15,000 km (9,000 miles) / 24 months

Valve clearance check 60,000 km (36,000 miles)

Emissions and Consumption**

Standard Euro 5

CO₂ emissions 162 g/km

Consumption 6,5 l/100 km



Indication of the mileage during which it is carried out the control and eventual adjustment of the valve clearance.

* Only for countries where 4ever Multistrada warranty applies.

** Only for countries where Euro 5 standard applies.

MULTISTRADA V4

Ducati Red



MULTISTRADA V4 S

Ducati Red



MULTISTRADA V4S

Aviator Grey



MULTISTRADA V4S Sport

Livrea Sport





Multistrada V4



Multistrada V4 S



Multistrada V4 S Sport

Ducati Quick Shift up/down (DQS)	
Suspension	
Wheel	
Front brake	
Instrumentation	
Dry weight	
Kerb weight	
Proiettore	
Ducati Cornering Lights (DCL)	
Ducati Multimedia System (DMS)	
Ducati Connect with full-map navigation system	
Vehicle Hold Control	
Cruise Control	
Hands-free system	
Carbon front mudguard	
Homologated silencer Akrapovic	

	○
Mechanical	
Light alloy cast	
2 x Ø 320 mm discs, Brembo callipers M 4.32	
5" TFT colour display	
215 kg (474 lb)	
240 kg (529 lb)	
Lamp	
-	
	○
-	
	○
	○
	-
	○
	○

	●
Semi-active Skyhook	
Light alloy cast / Spoked	
2 x Ø 330 mm discs, Brembo callipers M50 Stylema	
6.5" colour TFT display	
218 kg (480 lb)	
243 kg (535 lb)	
Full-LED	
	●
	●
	●
	●
	●
	●
	○
	○

	●
Semi-active Skyhook	
Light alloy cast / Spoked	
2 x Ø 330 mm discs, Brembo callipers M50 Stylema	
6.5" colour TFT display	
217 kg (478 lb)	
242 kg (533 lb)	
Full-LED	
	●
	●
	●
	●
	●
	●
	●
	●

● Standard ○ Optional accessory



Trim packs

Configure your Multistrada V4, and we'll produce your tailor-made version directly at the factory.

For the first time you have at your disposal, for the new Multistrada V4, five sets of predefined setups with which you can configure your bike with the safety and the quality of the original Ducati components. Essential, Radar, Travel & Radar and Full are the equipment set-ups that include alloy or spoked rims and a range of optional extras and factory fitted equipment.

Prepared by Ducati, personalized by you.

Essential



The indispensable trim for your Multistrada V4. The Essential equipment is designed to enjoy the riding experience on any road, in any condition.

Radar



The front and rear radar system allows for the operation of Adaptive Cruise Control and Blind Spot Detection, to ensure every journey is comfortable and safe.

Travel & Radar



The Travel & Radar package includes the radar system together with everything needed to enjoy the journey and the long distances: rigid side panniers, a central stand, and heated handgrips and seats.

Full



The complete equipment, equipped with all the optional extras, for those who do not want to give up on anything.



Accessory Packs

In addition to the new factory-fitted trims, Ducati offers traditional customization opportunities through a set of aftermarket accessory packages.

Touring Pack

Available for all models.
Side panniers, central stand, heated hand grips. For guaranteed comfort, however long the journey and however tough the weather conditions.

Urban Pack

Available for all models.
Top case, fuel tank bag, USB cable. Escape the city traffic with a greater load capacity and more technology.

Performance Pack

Available for V4 and V4 S.
Homologated Akrapovič silencer in titanium and carbon, carbon front mudguard. To enhance the Ducati sound and give the bike a more aggressive look.

Enduro Pack

Available for all models.
Radiator protection, lateral trellis protection, engine protection plate, additional LED lights. To increase vehicle protection and off-road functionality.

Functionality Pack

Only available for the standard V4.
To add advanced functionality such as DQS (Ducati Quick Shift), Vehicle Hold Control and Cruise Control to the standard version.



Configure your Multistrada V4



1 Gran Turismo windscreen.

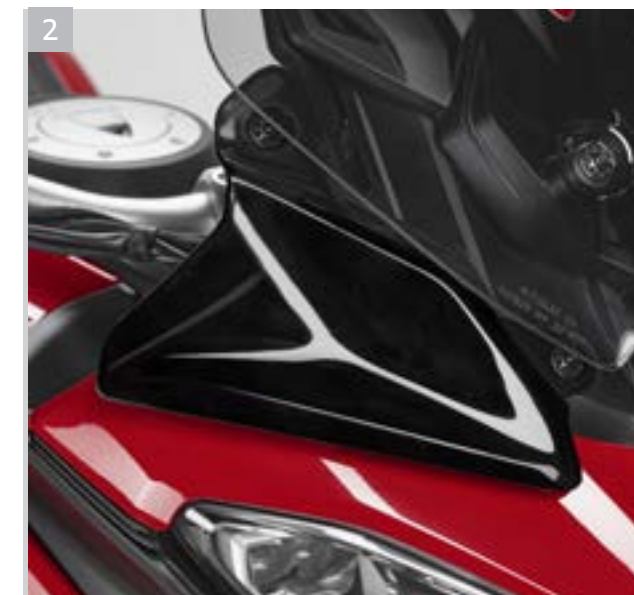

2 Smoke-tinted side deflectors.



3 Centre stand.



4 Hand guards.



5 Liners for plastic side panniers.





6 Enduro windscreen.



7 Handlebar bag.

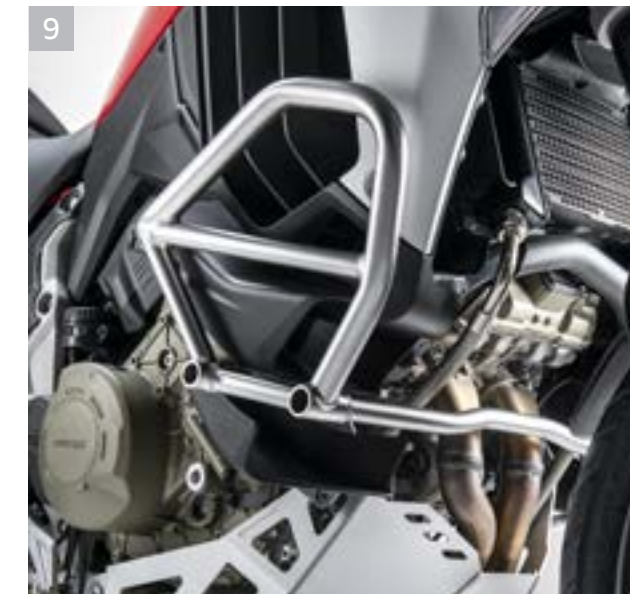

9 Engine guard in steel tubes.



8 Protective mesh for oil cooler.



10 Rider heated lowered seat.

T E

A



11 Rider heated raised seat.



12 Tank pocket bag.



13 Liner for plastic top case.



14 Tank protection.



15 Carbon headlight fairing.



16 Racing exhaust.



17 Brake fluid reservoir.
Clutch fluid reservoir.

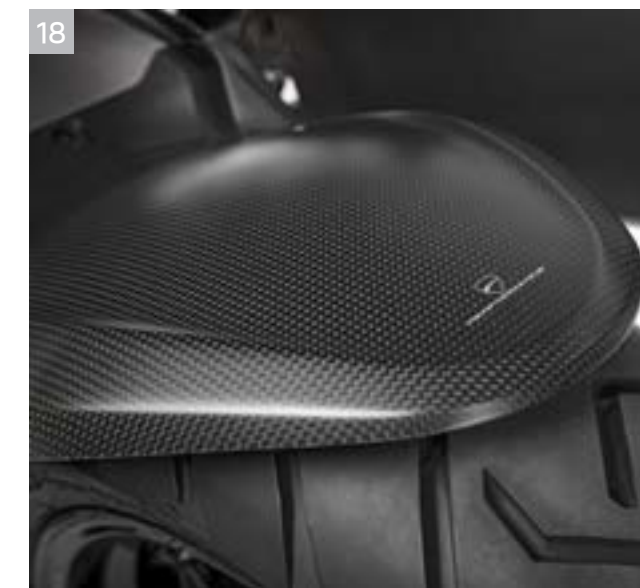

18 Carbon rear mudguard.



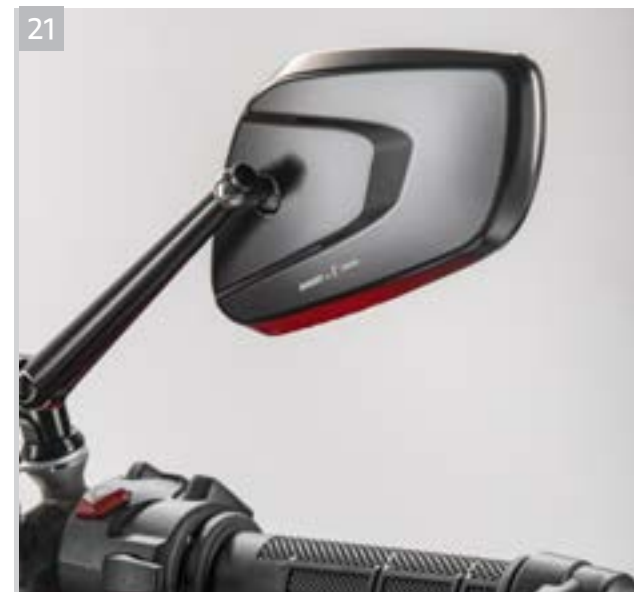

19 Carbon front mudguard.



21 LH aluminium rear-view mirror.



23 Billet aluminium tank cap.



20 Billet aluminium footpegs.



22 Front fork slider.



Flaunt your freedom

Tour V4
Full-face helmet

Atacama C1
Fabric jacket

Atacama C1
Fabric trousers

Strada C4
Fabric jacket

Strada C4
Fabric trousers



Ducati Apparel Collection designed by *Drudi Performance*





Tour V4
Full-face helmet

Ducatiana 2.0
T-shirt



Strada C4
Fabric jacket

Strada C4
Fabric trousers



The greatest journey

THE GENESIS OF THE MULTISTRADA V4

With its every generation, the Multistrada family further raises the bar so as to keep its initial promise: a versatile sports bike able to take on any terrain with maximum safety and solidity. The Multistrada V4 represents a new high and a new arrival point in terms of Ducati technological evolution from which to set off and reach any destination, on any road.

Step 1 A new start

"The Multistrada name encapsulates an ambitious promise to be kept: the challenge of providing riders with a versatile sports bike that can own any road, safely and robustly. We have always been committed to extending the field of use of the Multistrada, and this is still the case, 18 years and more than 110,000 bikes later. What goals did we set ourselves in defining



the new generation? We wanted the new Multistrada to be more high-performance but easy to ride. We wanted it to be more robust, but lightweight. We wanted it to be more versatile, but efficient in all situations. The new Multistrada V4 is more Multistrada than ever, a bike that combines the pleasure of sports riding on the road with the possibility of off-road use. A bike that is comfortable during both touring and everyday use."

Claudio Domenicali
CEO

Step 2 Winning design

"Right from the first meeting between our designers and engineers, it was clear what we wanted to achieve, namely a completely revised V4, with a new character, tailor made to suit the vehicle's mission of course."

Vincenzo De Silvio
Ducati R&D Director

"We've been able to ensure an ultra-compact volume, even more so than with the previous Testastretta DVT twin. 1.2 kg lighter, 85 mm shorter, and 95 mm lower, with an increase in width of just 20 mm. We have exceeded our expectations, so much so that, once we had our CAD model, we couldn't believe how much space was still available!."

Andrea Levati
V4 Granturismo Project Leader



"The compactness of the engine was the key to an integrated design approach that brings together chassis, ergonomics and design in the name of functionality. The basic concept was simple, or rather to define the riding position within the bike, and not on the bike, to transmit a real sense of integration with the vehicle and maximum control".

Andrea Amato - Multistrada V4 Senior Motorcycle Designer

Step 3 An obsession with perfection

"Three years of testing and development, to create a bike that can adapt to any terrain or riding level. This is the journey that led to the creation of the new Multistrada V4 and that involved significant teamwork between all departments".

**Pierluigi Zampieri
R&D Vehicle Director**

"As we promised in 2018, we are the first to introduce radar technology on a motorcycle. The culmination of a journey we began four years ago, this milestone sets a new standard in terms of comfort and riding assistance, especially over long distances on the motorway".

Andrea Ricci Iamino - Electrical and Electronic Systems Director



"In terms of timing, we carried out countless tests, from preliminary measurement with laser instrumentation, strain gauges and load cells, to motoring tests of more than 100 million cycles, which equates to more than twenty uninterrupted days".

**Gianluca Zattoni
V4 Granturismo Project Manager**

Step 4 Multistrada to the extreme

"The rumble of the engine is music to the ears of an enthusiast. This 'sound signature' shapes the personality and defines the spirit of the bike, and with the V4 Granturismo we were able to create the mix we wanted in terms of Ducati performance, regularity, and sound, in perfect harmony with the family feeling".

**Stefano Fantoni
Ducati Engine Director**

"For this bike, we doubled our target test mileage with respect to previous models. The Multistrada V4 is not only the most versatile Multistrada of all time, but also the most reliable. An unstoppable machine that can take on any journey, in any conditions".

**Marco Barbati
Vehicle Development Engineer**

A world of emotions

Months and months spent on roads and dirt tracks across Italy, testing solutions and analysing bike behaviour. To guarantee future owners of the new Multistrada V4 all the excitement and comfort of a care-free ride, Ducati test riders Alessandro Valia and Andrea Rossi were sure to leave no stone unturned.

"When your name is Multistrada, you know you are raising the bar, but the Multistrada V4 exceeds every expectation you might have of it. It can surprise you in every situation, providing a new sense of freedom and the very real sensation that you are not just riding the roads, but owning them."

"Over long distances, the bike is extremely comfortable. Vibration and noise are reduced to a minimum, as is heat. Even after 800 km, you get off the bike relaxed and ready to enjoy your destination".

"The bike immediately transmits a real sense of agility. You can really feel the centre of gravity, now further forward, and this makes the bike very easy to handle when riding it, but also when simply positioning it on the central stand or moving it with the engine off".

"Thanks to the compactness of the engine and its ideal positioning, we have obtained a narrow seat that is much more beneficial with respect to the previous MTS. As a result, the rider enjoys greater sensitivity with the ground and that typical Ducati sensation of feeling as one with the bike".

"The seat, bike profile, and leg space were all designed to ensure every rider is comfortable. Not every rider is the same after all, and when you're on board a Multistrada you want to be able to enjoy all types of road that a journey might offer, with maximum freedom and in comfort."

Alessandro Valia



“There’s no doubt about it, the Multistrada V4 has all the characteristics for an outstanding ride, even off-road, and for all riders, whatever their level. The less experienced can have fun riding a bike that has never been so agile, while expert riders can enjoy the stability at high speeds and the ever-available torque guaranteed by the new engine.”

“The V4 Granturismo fully reflects the bike’s philosophy. It is extremely smooth and progressive, able to go from amazing flexibility at low revs, where a more direct throttle response gives you the right power to overcome obstacles, to Ducati V4 power at high revs, where you feel the full effects of 170 hp.”



“The perfectly positioned centre of gravity ensures a true feeling of control at low speeds on the dirt. And the position when standing on the pegs is more natural too, with no annoying contact points. The rider is free to move in any direction without interference.”

“The versatility of the Multistrada V4 is also highlighted by a new feature, its 19” front wheel, which is suitable for both long road trips and off-road riding. And thanks to the double-sided rear swingarm, the Multistrada V4 can be equipped with spoked wheels and Pirelli Rally or Rally Street knobby tyres, for a heightened enduro feel.”

Andrea Rossi

Ducati Experience

Expand your Multistrada experience. With the Ducati Experience you can access a vast catalog of riding experiences, suitable for riders of all levels. Improve your technique, learn how to get the most out of your bike, or discover fascinating places with other enthusiasts and under the guidance of professional instructors: whatever your goal, with the Ducati Riding Academy you will be able to live unforgettable moments and make your bond with the Multistrada even stronger.

Visit the website dre.ducati.com to discover the updated calendar of initiatives and all the ways to participate.



@ducatimultistradaV4 on Instagram

An Instagram profile dedicated to new emotions to live. Endless roads to travel. New horizons to explore. A new world to discover.

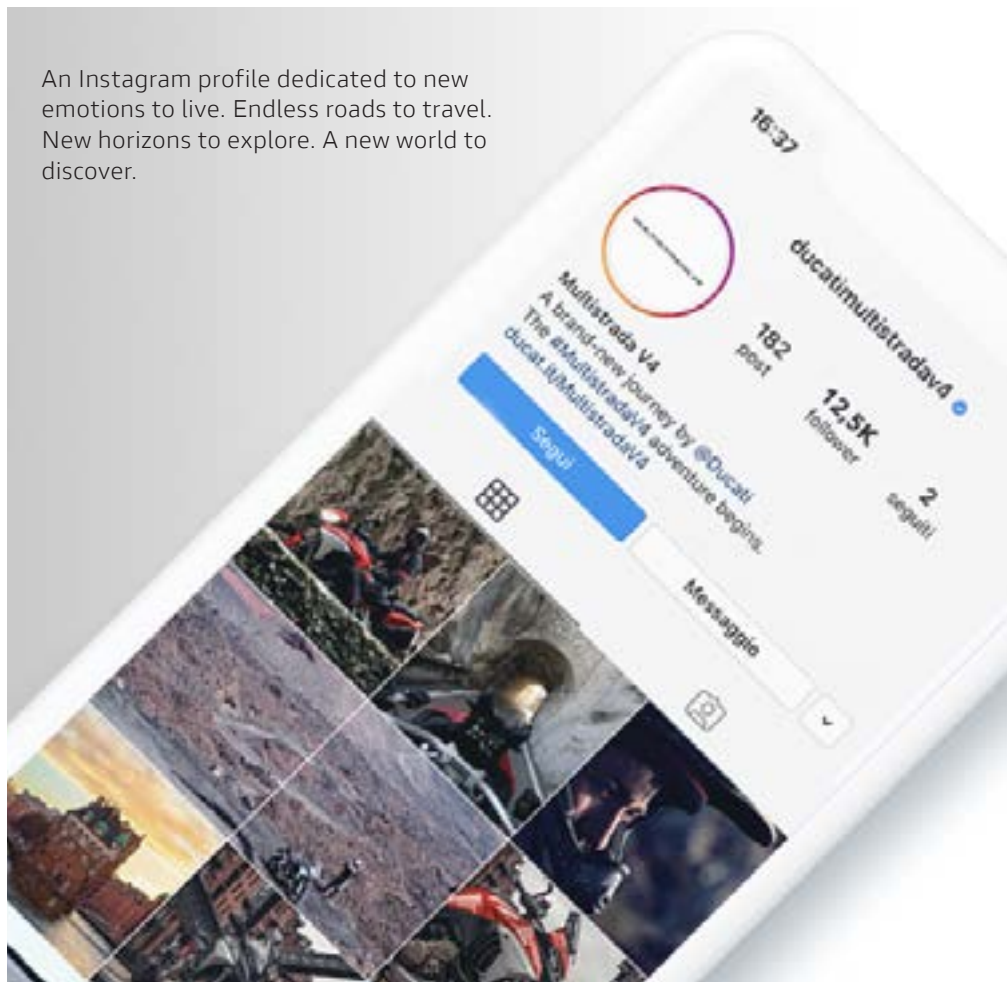

Riding a motorcycle is the most exciting way to enjoy the road, and offering the utmost safety to the motorcyclist is Ducati's commitment. Ducati bikes are increasingly easy to handle, reliable and better equipped to guarantee maximum safety and enhance riding pleasure. Technical clothing is made with more and more advanced materials for adequate protection and increased visibility. The safety of motorcyclists is Ducati's commitment. For more information visit the safety section of the Ducati site (www.ducati.com).

Warning: The photos and technical information in this catalogue may refer to prototypes subject to modifications during production and are purely for illustration and reference purposes, and are therefore not binding on Ducati Motor Holding S.p.A. Sole Shareholder Company - Company subject to the direction and coordination of AUDI AG ("Ducati"). Ducati cannot be held responsible for any print and/or translation errors. This catalogue is transnational and therefore some products may not be available and/or their features may vary in accordance with local laws. Not all colours and versions are available in each country. Ducati reserves the right to make changes and improvements to any product without obligation of prior notice or to make such changes to products already sold. Further characteristics of the products

are contained in the pertinent owner's manuals. The products represented are not definitive versions and are therefore subject to significant changes at Ducati's discretion without prior notice. The photographs published in this catalogue show only professional riders under controlled street conditions. Do not attempt to imitate such riding behaviour as it could be dangerous for you or other people on the road. This catalogue, including but not limited to the trademarks, logos, texts, images, graphics and table of contents herein, constitute Ducati intellectual property, or in any event Ducati has the right to reproduce it; any reproduction, modification or other whole or partial use of the catalogue or its contents, including publication on the Internet without the prior written consent of Ducati, is prohibited.

Actual fuel consumption may vary based on many factors, including but not limited to riding style, maintenance performed, weather conditions, surface characteristics, tyre pressure, load, weight of the rider and the passenger, accessories.

Ducati indicates the dry weight of the motorcycle excluding battery, lubricants and coolants for liquid-cooled models. The weights in running order are considered with all operating fluids, standard equipment and the fuel tank filled to 90% of its useful capacity (UE regulation no. 168/2013). For more information visit www.ducati.com.

November 2021



ducati.com

Developed with 

Technical partner 

Technical partner 