

DIAVEL





Index

4	Born to be a star	34	Accessories. Configure the Ducati of your dreams
7	Lights on me	40	Apparel
11	Contemporary style	44	Ducati Digital Experience
14	Innovation and performance		
17	Enhance your riding pleasure		
19	Touring soul		
22	Servicing and maintenance		
25	Technical data and equipment		

Born to be a star

Powerful. Muscular. Agile. For maximum riding pleasure.

The Diavel 1260 combines the performance of a maxi-naked with the ergonomics of a muscle cruiser. Its modern design reinterprets the Diavel and perfectly integrates the Euro 5-homologated, 162 HP* Testastretta DVT 1262 engine, the beating heart of the Diavel 1260.

The Testastretta DVT delivers 162 HP* at 9500 rpm with a flat and full-bodied torque curve, for blistering acceleration as well as that low-speed consistency ideal for touring or daily use.

Standing out for its distinctive 240 mm rear tyre, the chassis ensures surprising handling and lean angles, combined with an excellent level of comfort for both rider and passenger.





Lights on me

New for 2022 in the Diavel's family is the "Black and Steel", its refined and asymmetric graphics pairing polished grey and matte black with touches of sporty yellow.

The Diavel 1260 S "Black and Steel" is inspired by the concept of the Diavel "Materico", presented during the 2019 "Beautiful Boldness/Visionary Design" event at Milano Design Week before being exhibited at MOARD (Motorcycle Art & Design), the dedicated motorcycle design show.

Every rider is a star aboard the Diavel 1260 S "Black and Steel".





Contemporary style

Synonymous with style, innovation, and performance, the Diavel 1260 has won prestigious international prizes such as the “Red Dot Award” and the “Good Design Award”.

The muscular lines and the unmistakable front section give the Diavel 1260 S unique character and personality, while the large air vents and trellis frame skirt the engine.

The agile, sleek tail section stands out for the unmistakable 240 mm rear tyre. Öhlins suspension enriches the design and enhances the performance and riding comfort.



Innovation and performance

The beating heart of the unconventional and unmistakable Diavel 1260 soul is the 1262 cc Testastretta DVT engine that delivers 162 HP* at 9500 rpm with a flat and full-bodied torque curve, for blistering acceleration as well as that low-speed consistency ideal for touring or daily use.

Advanced electronics ensure maximum riding pleasure in all conditions, while engine character and response can be customised at any time with the Ride by Wire control associated with the three Power Modes.

Active safety is always at a max thanks to Ducati Wheelie Control Evo and the Ducati Safety Pack, which includes Cornering ABS Evo and Ducati Traction Control Evo.

The Ducati Quick Shift, as standard on the S version, allows for ultra-rapid up and downshifting.

The full LED headlight with DRL system** ensures the Diavel 1260 S is recognisable at first glance.

The Diavel 1260 dash comprises a 3.5" colour TFT display with four different viewing modes - Default, Track, Full and City - paired with the Sport, Touring and Urban Riding Modes. The light module is separate, located above and below the handlebar. The handlebar buttons are back-lit.

* Euro 5 version

** Please check with your dealer feature availability.





Enhance your riding pleasure

The Diavel 1260 marries personality, sports attitude, and comfort. The trellis frame offers lightness and stiffness, while the adjustable 50 mm fork ensures comfort and precision during sports riding.

The combination of high handlebar, low seat and central footpegs makes for a low centre of gravity and a comfortable position, for riding ease in all conditions. The generous seat ensures a comfortable ride, even for two.

On the S version, special components and refined details highlight the unique style of the Diavel 1260. The design is enhanced with the dedicated seat and exclusive machined wheels.

Brembo M50 brake callipers, fully adjustable Öhlins suspension with its unmistakable gold finish, and the Ducati Quick Shift up & down round out the standard equipment on the Diavel 1260 S, underlining its sports nature.



Touring soul

The Diavel 1260 is once again ready to amaze as it reveals its touring soul, for dynamism and comfort on even the longest trips. By accessorising the Diavel 1260 with the Touring Pack, or rather semi-rigid side panniers, a passenger backrest and heated hand grips, you can enjoy the bike's all-round touring spirit. Get ready for a new way of travel, as bold as your Diavel. The adventure you never imagined starts now.





Servicing and maintenance

Safety as standard

The continuous work that Ducati carries out in terms of design, research and development serves to ensure cutting edge bikes characterised by maximum active safety levels. A commitment that involves the definition of increasingly advanced technological systems to increase the rider's level of control, such as the Ducati Safety Pack (DSP) that, for Diavel 1260, includes Cornering ABS Evo and Ducati Traction Control Evo (DTC).

More value to your passion

With Ever Red, the quality and reliability of the Ducati brand remain your inseparable travelling companions over time. Ever Red is the exclusive Ducati warranty extension programme. With its activation you can continue to feel protected for 12 or 24 months beyond the expiration of the Ducati Warranty (24 months). Ever Red includes roadside assistance for the entire coverage period and no mileage limits. In this way you can ride for all the kilometres you want, even abroad, enjoying your Ducati without any worries.

To find out if the Ever Red extension is available in your country and for further information contact your Ducati dealer or visit ducati.com.

Endless excitement

In designing each bike, Ducati constantly strives to ensure maximum reliability while reducing service costs. A commitment that has seen the intervals for the main Desmo Service, in which valve clearance is checked and adjusted if necessary, to be extended to 30,000 km (18,000 miles) for the Diavel 1260.

Even the simplest of checks, such as the Oil Service, are extended to 15,000 km (9,000 miles) or 12 months. A considerable interval for such high performance engines, which only confirms the high quality standards adopted in terms of material selection and R&D processes. Ducati continuously invests in the technical training of its dealers.

The specific skills offered by the official Ducati Service network ensure that all those operations needed to keep every Ducati in perfect condition are thoroughly executed, while advanced equipment such as the Ducati Diagnosis System allows the software on each Ducati to be updated with the latest releases, ensuring that the electronics continue to perform at the maximum level.

Always by your side

One of Ducati's main goals is to offer every Ducatista the chance to enjoy unlimited and safe travel all over the world. To achieve this aim, Ducati offers a "fast delivery" original spares service, with delivery in 24/48 hours across 85% of the areas in which it operates. With a distribution network that covers more than 91 countries, thanks to 738 official Dealers and Service Points*, choosing a Ducati means you can travel worry free and in total freedom, wherever the road may take you, and count on support from our extensive Dealer network that ensures Ducati quality and professionalism is always close at hand.

738 Authorised dealers and service points

91 World countries

*Information updated as of February 2021



Ever Red
Extended Warranty



*Equal to 18,000 miles.





Technical data and equipment

DIAVEL 1260

Dimensions

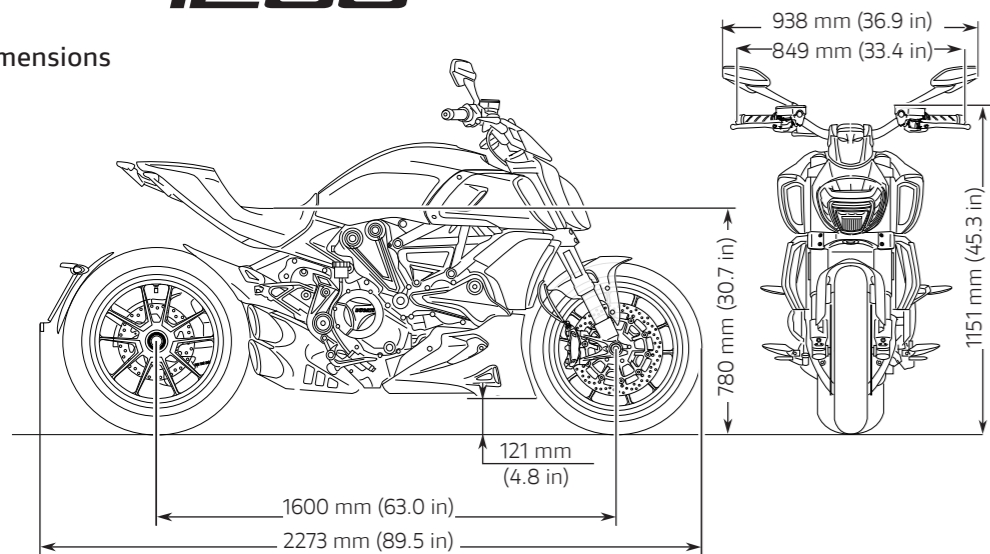

Power and torque*

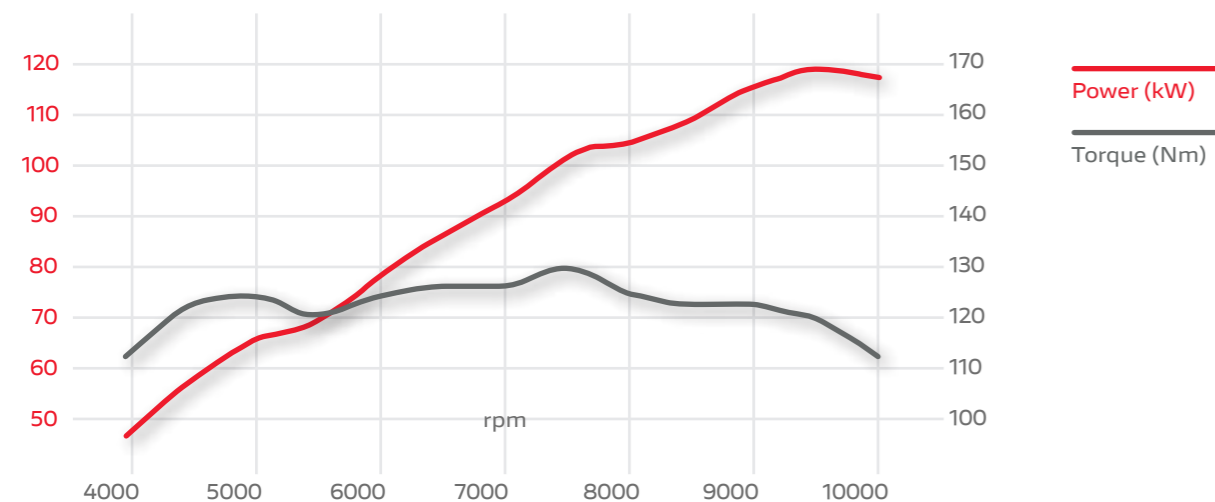

Engine	
Engine	Ducati Testastretta DVT 1262, L-Twin cylinder, 4 valves per cylinder, Dual Spark, Liquid cooled, Desmodromic Variable Timing
Displacement	1,262 cc (77.0 cu in)
Bore X stroke	106 x 71.5 mm
Compression ratio	13.0 : 1
Maximum power	162 hp (119 kW) @ 9,500 rpm* 157 hp (116 kW) @ 9,250 rpm** 159 hp (117 kW) @ 9,500 rpm ***
Maximum torque	13.2 kgm (129 Nm, 95 lb ft) @ 7,500 rpm
Fuel injection	Electronic fuel injection system, Øeq 56 mm elliptical throttle bodies with Ride-by-Wire system
Exhaust	Stainless steel silencer, catalytic converter and two lambda probes
Transmission	
Gearbox	6 speed
Primary drive	Straight cut gears, Ratio 1.84:1
Ratio	1=37/15, 2=30/17, 3=27/20, 4=24/22, 5=23/24, 6=22/25
Final drive	Chain, Front sprocket Z15, Rear sprocket Z43
Clutch	Slipper and self-servo wet multiplate clutch with hydraulic control

Chassis	
Frame	Tubular steel trellis frame
Front suspension	Ø 50 mm adjustable usd fork
Front wheel	Light alloy cast 3.5"x17"
Front tyre	Pirelli Diablo Rosso III 120/70 ZR17
Rear suspension	Monoshock, preload and rebound adjustable, Aluminium casted single-sided swingarmw
Rear wheel	Light alloy cast 8.0"x17"
Rear tyre	Pirelli Diablo Rosso III 240/45 ZR17
Wheel travel (front/rear)	120 mm / 130 mm (4.7 in / 5.1 in)
Front brake	2 x Ø 320 mm semi-floating discs, Radially mounted Brembo monobloc 4-piston M4.32 callipers, PR18/19 radial master cylinder, Cornering ABS Evo
Rear brake	Ø 265 mm disc, 2-piston Brembo floating calliper, Cornering ABS Evo
Instrumentation	3.5" TFT colour display and dedicated warning light display

Dimensions and Weights	
Dry weight	223 kg (492 lb)
Kerb weight	249 kg (549 lb)
Seat height	780 mm (30.7 in)
Wheelbase	1,600 mm (63.0 in)
Rake	27°
Front wheel wtrail	120 mm (4.7 in)
Fuel tank capacity	17 l (4.5 US gal) 16 l (4.2 US gal)**
Number of seats	2

Standard Equipment

Riding Modes, Power Modes, Ducati Safety Pack (Cornering ABS Evo, Ducati Traction Control Evo DTC), Ducati Wheelie Control Evo (DWC), Cruise control, Ducati Power Launch Evo (DPL), Hands-Free, Backlit handlebar switches, 3.5" TFT colour display, Full LED lighting system, Self cancelling turn indicators. Ready for : Ducati Quick Shift up/down Evo (DQS), Ducati Multimedia System (DMS), Antitheft system

Warranty

24 months, Unlimited mileage

Maintenance	
Maintenance service intervals	15,000 km (9,000 miles) / 12 months
Valve clearance check	30,000 km (18,000 miles)
Emissions & Consumption*	
Standard	Euro 5
CO₂ Emissions	129 g/km
Consumption	5,5 l/100 km



Equal to 18,000 miles.

* Only for countries where Euro 5 standard applies.
** Only for US, Canada and Mexico.
*** Other countries.

DIAVEL 1260S

	Diavel 1260	Diavel 1260 S
Front Suspension	Ø 50 mm fully adjustable usd fork	Ø 48 mm Öhlins fully adjustable usd fork, TiN treatment
Rear Suspension	Monoshock, preload and rebound adjustable	Öhlins fully adjustable monoshock
Seat	Standard	Premium with insert
Front Brake	Radially mounted Brembo monobloc 4-piston M4.32 callipers, PR18/19 radial master cylinder	Radially mounted Brembo monobloc 4-piston M50 callipers, PR16/19 radial master cylinder
Wheels	Cast	Cast and machined
Daytime Running Light (DRL)	-	Standard*
Ducati Quick Shift up/down (DQS)	Accessory	Standard
Ducati Multimedia System (DMS)	Accessory	Standard
Dry weight	223 kg (492 lb)	221 kg (487 lb)
Kerb weight	249 kg (549 lb)	247 kg (544 lb)

* Please contact your dealer for information on availability.



1 Fully adjustable front and rear Öhlins suspension with golden finish



2 Exclusive cast and machine-processed rims



3 Premium seat with Diavel insert

DIAVEL 1260

Dark Stealth



DIAVEL
1260S

Black and Steel



DIABVEL
1260S

Dark Stealth & Thrilling Black



ACCESSORIES

Configure the Ducati of your dreams.

Numerous accessories have been created to enhance the pleasure of riding, and highlight the sports attitude, elegance, and comfort of the Diavel 1260.

To express the various sides to its personality, Ducati has created three packages - Sport, Touring and Urban. Machined aluminium and carbon are combined in a Sport package that exalts the powerful and muscular character of the Diavel 1260.

For those who want to travel, alone or in company, the Touring package is the perfect complement, highlighting the bike's cruiser qualities. The Urban package stands out for its bold, refined design with machined aluminium details that highlight a unique, irreverent elegance.

Configure

Choose your ideal Diavel 1260 and have fun configuring it to suit your riding style! Share your Diavel 1260 with friends or send it to your Ducati dealer who will contact you for an online consultation to discuss the current offers that best suit your needs.

Save your configuration to return to it at any time.

Calculate your payment

Ducati Financial Services offers favourable solutions for the financing of every model in the Ducati range. Personalise your financing and calculate the monthly instalments. You can then contact your dealer and discuss the best way to see your dream come true!



Go to configurator

For more information about the Ducati Performance range, tech specs and instructions, refer to a Ducati dealer or visit the Accessories section of website ducati.com



1 Premium seat



2 Billet aluminium rearview mirrors

OK A ■ ■



3 Covers for brake and clutch fluid reservoirs

A



4 Billet aluminium tank cap

A



5 Brake lever

A



1 Set of semi-rigid side panniers

2 Passenger rear backrest



3 Smoked Sport Headlight Fairing



4 Complete exhaust assembly



5 Carbon rear mudguard



6 Billet aluminium sprocket cover



Apparel

Black Steel
Full-face helmet

Black Rider
Leather jacket

Ducatiana 2.0
T-shirt

Sport C3
Leather-fabric gloves

Company C3
Technical jeans

D-Attitude
Full-face helmet



Ducati Apparel Collection designed by *Drudi Performance*





Race

Quartz watch

Ducati Corse Redline

Quartz Chronograph

Road Master

Quartz watch

Ducati

Block Notes

Urban

Key-ring

Dovizioso

Sunglasses

Ducati Delux

Key-ring

Ducati Corse 14

Ball pen

Reflex Attitude

Sweatshirt

Urban Stripes

Leather jacket

Reflex Attitude

Short-sleeved polo shirt

Stripe pocket

Umbrella

Acapulco

Sunglasses

Reflex Flex

Cap

Ducatiana 80s





T-shirt



Ducati Digital Experience

A mission for every channel. Continuous updating on the innovation and passion for which our work stands out. We transform emotions into exclusive content. Just a click away.

Follow us on:

-  @ducati
-  @DucatiMotor
-  Ducati Motor Holding
-  @ducati
-  Ducati Motor Holding

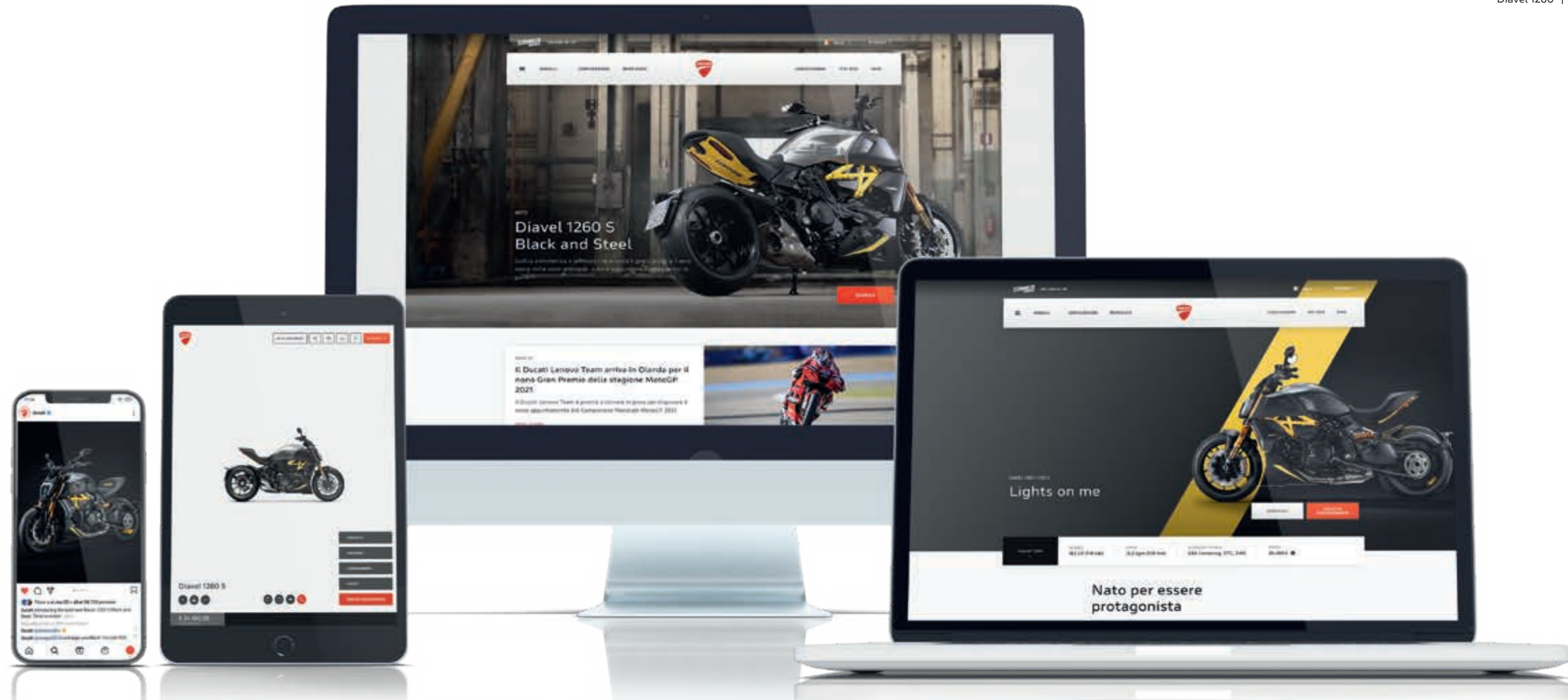

Key to symbols

 For racing use only - The product marked with this symbol can only be used on competition vehicles. Use outside a competition track of motorcycles equipped with this product is prohibited by law. Verify any further restrictions with the relevant race course. Motorcycles equipped with this accessory are prohibited from operating on public roads.

 This accessory is not approved for road circulation

 This accessory is approved for road circulation in Europe

 Anodized

 Black

 Matt

 Silver

 Tinted

 This product is intended for vehicles used only in closed-course competition. Operation on public roads is prohibited by law.



ducati.com

Riding a motorcycle is the most exciting way to enjoy the road, and offering the utmost safety to the motorcyclist is Ducati's commitment. Ducati bikes are increasingly easy to handle, reliable and better equipped to guarantee maximum safety and enhance riding pleasure. Technical clothing is made with more and more advanced materials for adequate protection and increased visibility. The safety of motorcyclists is Ducati's commitment. For more information visit the safety section of the Ducati site (www.ducati.com).

Warning: The photos and technical information in this catalogue may refer to prototypes subject to modifications during production and are purely for illustration and reference purposes, and are therefore not binding on Ducati Motor Holding S.p.A. Sole Shareholder Company - Company subject to the direction and coordination of AUDI AG ("Ducati"). Ducati cannot be held responsible for any print and/or translation errors. This catalogue is transnational and therefore some products may not be available and/or their features may vary in accordance with local laws. Not all colours and versions are available in each country. Ducati reserves the right to make changes and improvements to any product without obligation of prior notice or to make such changes to products already sold. Further characteristics of the products are contained in the pertinent owner's manuals. The products represented are not definitive versions and are therefore subject to significant changes at Ducati's discretion without prior notice. The photographs published in this catalogue show only professional riders under controlled street conditions. Do not attempt to imitate such riding behaviour as it could be dangerous for you or other people on the road. This catalogue, including but not limited to the trademarks, logos, texts, images, graphics and table of contents herein, constitute Ducati intellectual property, or in any event Ducati has the right to reproduce it; any reproduction, modification or other whole or partial use of the catalogue or its contents, including publication on the Internet without the prior written consent of Ducati, is prohibited.

Actual fuel consumption may vary based on many factors, including but not limited to riding style, maintenance performed, weather conditions, surface characteristics, tyre pressure, load, weight of the rider and the passenger, accessories.

Ducati indicates the dry weight of the motorcycle excluding battery, lubricants and coolants for liquid-cooled models. The weights in running order are considered with all operating fluids, standard equipment and the fuel tank filled to 90% of its useful capacity (UE regulation no. 168/2013). For more information visit www.ducati.com. July 2021.



Developed with



Technical partner

